







## Sospensioni Integrative per veicoli commerciali Integrative Suspensions for commercial vehicles



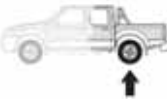

Top Drive System Ref. :  **583091**  
**583091AC** 



<b>M</b>	Gonfiaggio <i>Inflating</i>	Posteriore <i>Rear</i>
	Manuale <i>Manual</i>	
<b>AC</b>	Controllo Automatico <i>Automatic control</i>	Torpress 279 B
		 Ø6"
		550041 - 550031

**Hilux Pick-Up**  
Prima serie / First version



Data / Date		Dettagli veicolo / Vehicle's detail	
Da / Since :			Balestra sopra l'assale <i>Leaf spring on axle</i>
Fino a / Until:			
Tipo assale / Axle type		Ruota / Wheel	
	Tondo / Round		Singola - 4x4 Single - 4x4



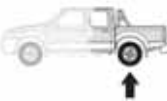

Top Drive System Ref. :  **583090**  
**583090AC** 



<b>M</b>	Gonfiaggio <i>Inflating</i>	Posteriore <i>Rear</i>
	Manuale <i>Manual</i>	
<b>AC</b>	Controllo Automatico <i>Automatic control</i>	Torpress 279 B
		 Ø6"
		550041 - 550031



**Hilux Pick-Up**  
Seconda serie / Second version



Data / Date		Dettagli veicolo / Vehicle's detail	
Da / Since :			Balestra sotto l'assale <i>Leaf spring under axle</i>
Fino a / Until:			
Tipo assale / Axle type		Ruota / Wheel	
	Tondo / Round		Singola - 4x4 Single - 4x4



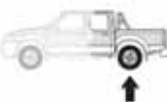

Top Drive System Ref. :  **583099**  
**583099AC** 

<b>M</b>	Gonfiaggio <i>Inflating</i>	Posteriore <i>Rear</i>
	Manuale <i>Manual</i>	
<b>AC</b>	Controllo Automatico <i>Automatic control</i>	Torpress 279 B
		 Ø6"
		550041 - 550031

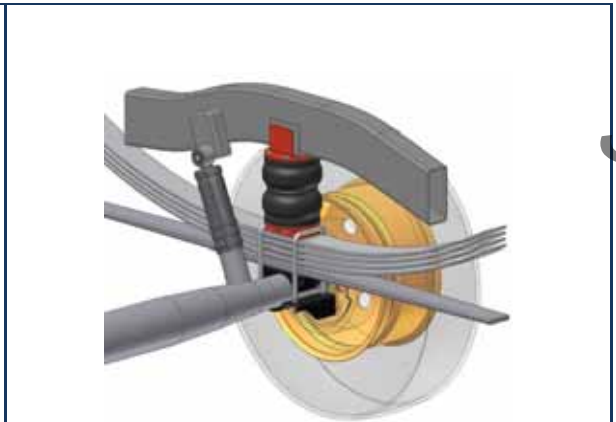
**Hilux 300 Pick-Up**  
2.5 D-4D 4x4 Extra Cab  
2.5 - 3.0 D-4D 4x4 Double Cab



Data / Date		Dettagli veicolo / Vehicle's detail	
Da / Since :	01/2006		Balestra sopra l'assale <i>Leaf spring on axle</i>
Fino a / Until:			
Tipo assale / Axle type		Ruota / Wheel	
	Tondo / Round		Singola - 4x4 Single - 4x4

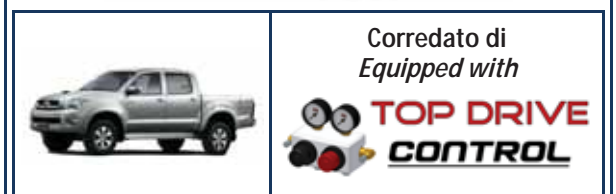



Sospensioni Integrative per veicoli commerciali  
*Integrative Suspensions for commercial vehicles*



Top Drive System Ref. : <b>43500101</b> <b>43500109</b>		Gonfiaggio <i>Inflating</i>	Posteriore <i>Rear</i>	
		Manuale <i>Manual</i>		
<b>Hilux 300 Pick-Up</b> 2.5 D-4D 4x4 Extra Cab 2.5 - 3.0 D-4D 4x4 Double Cab	<b>AC</b>	Controllo Automatico <i>Automatic control</i>	Torpress 279 B Ø6" 	550041 - 550031
Data / Date Da / Since : <b>01/2006</b> Fino a / Until:		Dettagli veicolo / Vehicle's detail Balestra sotto l'assale <i>Leaf spring under axle</i>		
Tipo assale / Axle type Tondo / Round 80		Ruota / Wheel Singola - 4x4 Single - 4x4		
		Corredato di Equipped with 		

www.pneumauto.by



WWW.TOPDRIVESYSTEM.COM