



Sospensioni Integrative per veicoli commerciali Integrative Suspensions for commercial vehicles



Top Drive System Ref. :  **583010**
583010AC 

M	Gonfiaggio <i>Inflating</i> Manuale <i>Manual</i>
AC	Controllo Automatico <i>Automatic control</i>

B 70 - B 80 - B 110 - B 120 - 130.65
Messenger
Master
 Fino ad esaurimento scorte / Until stocks last

Posteriore
Rear





Torpress 279 B

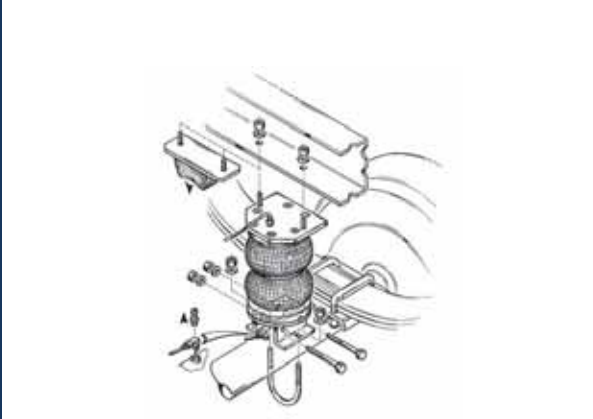

Ø6"

550041 - 550031



Data / Date		Dettagli veicolo / Vehicle's detail	
Da / Since :			
Fino a / Until:			
Tipo assale / Axle type		Ruota / Wheel	
	Tondo / Round Ø90 Tipo 569 Ø106 Tipo 669		Gemellata Tween





Corredato di
Equipped with





Top Drive System Ref. : **583710**
Master X70

R330 - R350 (Euro 4 - Euro 5)
 Molle rinforzate per assale anteriore (conf. Da 2 pezzi) /
front axle reinforced springs (2 pcs. package)

Anteriore
Front

Data / Date		Dettagli veicolo / Vehicle's detail	
Da / Since :	1997		
Fino a / Until:	2010		
Tipo assale / Axle type		Ruota / Wheel	
NA	Non applicabile / Not Applicable		Mc Pherson Mc Pherson



Top Drive System Ref. :  **583006**
583006AC 

M	Gonfiaggio <i>Inflating</i> Manuale <i>Manual</i>
AC	Controllo Automatico <i>Automatic control</i>

Master 2

Posteriore
Rear





Torpress 279 B



Ø6"

550041 - 550031



Data / Date		Dettagli veicolo / Vehicle's detail	
Da / Since :	03/1998		
Fino a / Until:	02/2010		
Tipo assale / Axle type		Ruota / Wheel	
	Tondo / Round		Singola - trazione anteriore Single - FWD



Corredato di
Equipped with





Sospensioni Integrative per veicoli commerciali Integrative Suspensions for commercial vehicles



Top Drive System Ref. :
43011261
43011266

	Gonfiaggio <i>Inflating</i>	Posteriore <i>Rear</i>
M	Manuale <i>Manual</i>	
AC	Controllo Automatico <i>Automatic control</i>	Torpress 275 C Ø7.3"
		550054

Master 2 - Furgone/ Van
 Modifica sospensione originale / *Original suspension modification*

Data / Date		Dettagli veicolo / Vehicle's detail	
Da / Since :	03/1998	Furgone Van	
Fino a / Until:	02/2010		
Tipo assale / Axle type		Ruota / Wheel	
	Tondo / Round		Singola - trazione anteriore Single - FWD



Corredato di
Equipped with



Top Drive System Ref. :
43011301
43011306

	Gonfiaggio <i>Inflating</i>	Posteriore <i>Rear</i>
M	Manuale <i>Manual</i>	
AC	Controllo Automatico <i>Automatic control</i>	Torpress 281 Ø8"
		550043 - 550033

Master 2 - Telaio/Chassis
 Modifica sospensione originale / *Original suspension modification*

Data / Date		Dettagli veicolo / Vehicle's detail	
Da / Since :	03/1998	Telaio Chassis	
Fino a / Until:	02/2010		
Tipo assale / Axle type		Ruota / Wheel	
	Tondo / Round		Singola - trazione anteriore Single - FWD



Corredato di
Equipped with



Top Drive System Ref. :
550016

Master Tipo 2 Fase 3
 Diapress completo per sospensione originale (Dunlop) /
Original suspension complete Diapress (Dunlop)

	Gonfiaggio <i>Inflating</i>	Posteriore <i>Rear</i>
M	Manuale <i>Manual</i>	
AC	Controllo Automatico <i>Automatic control</i>	Diapress LCV originale Du Ø6"
		550016

Data / Date		Dettagli veicolo / Vehicle's detail	
Da / Since :	03/1998		
Fino a / Until:	02/2010		
Tipo assale / Axle type		Ruota / Wheel	
	Tondo / Round		Singola - trazione anteriore Single - FWD



Corredato di
Equipped with





Sospensioni Integrative per veicoli commerciali Integrative Suspensions for commercial vehicles



Top Drive System Ref. :

583306

Master Tipo 2 Fase 3

Compressore per sospensioni originali (Dunlop) -
Centralina elettronica non inclusa / *Original suspensions
air compressor (Dunlop) - Electronic switchboard not
included*

Posteriore
Rear



Data / Date		Dettagli veicolo / Vehicle's detail	
Da / Since :	03/1998		
Fino a / Until:	02/2010		
Tipo assale / Axle type		Ruota / Wheel	
	Tondo / Round		Singola - trazione anteriore Single - FWD

Top Drive System Ref. :

583047

583047AC

Mascott - Master Propulsion

90.35 110.35 120.35
130.35 130.60 160.35 160.65



Gonfiaggio
Inflating

Manuale
Manual

Controllo Automatico
Automatic control

Posteriore
Rear



Torpress 279 B
Ø6"



550041 - 550031



Data / Date		Dettagli veicolo / Vehicle's detail	
Da / Since :	01/1999		
Fino a / Until:	02/2010		
Tipo assale / Axle type		Ruota / Wheel	
	Tondo / Round Ø90-110 Tipo/Type 569		Gemellata Tween



Corredato di
Equipped with



Top Drive System Ref. :

583711

Master 3 (X62)

Molle rinforzate per assale anteriore (conf. Da 2 pezzi) /
front axle reinforced springs (2 pcs. package)

Anteriore
Front





Data / Date		Dettagli veicolo / Vehicle's detail	
Da / Since :	03/2010		
Fino a / Until:	05/2014		
Tipo assale / Axle type		Ruota / Wheel	
NA	Non applicabile / Not Applicable		Mc Pherson Mc Pherson





Sospensioni Integrative per veicoli commerciali Integrative Suspensions for commercial vehicles



Top Drive System Ref. :  **583132**
583132AC 

M	Gonfiaggio <i>Inflating</i> Manuale <i>Manual</i>
AC	Controllo Automatico <i>Automatic control</i>

Master 3 (X62)
R330 - R350 (Euro 4 - Euro 5)

Data / Date		Dettagli veicolo / Vehicle's detail	
Da / Since :	03/2010		Passo fino a 3682 mm <i>Wheelbase up to 3682 mm</i>
Fino a / Until:	05/2014		
Tipo assale / Axle type		Ruota / Wheel	
	Quadro / Square		Singola - trazione anteriore Single - FWD

Posteriore
Rear





Torpress 279 B
Ø6"
550041 - 550031







Corredato di
Equipped with
TOP DRIVE CONTROL



Top Drive System Ref. :  **43013201**
43013209 

M	Gonfiaggio <i>Inflating</i> Manuale <i>Manual</i>
AC	Controllo Automatico <i>Automatic control</i>

Master 3 (X62)
R330 - R350 (Euro 4 - Euro 5)

Data / Date		Dettagli veicolo / Vehicle's detail	
Da / Since :	03/2010		Passo fino a 3682 mm <i>Wheelbase up to 3682 mm</i>
Fino a / Until:	05/2014		
Tipo assale / Axle type		Ruota / Wheel	
	Quadro / Square		Singola - trazione anteriore Single - FWD

Posteriore
Rear



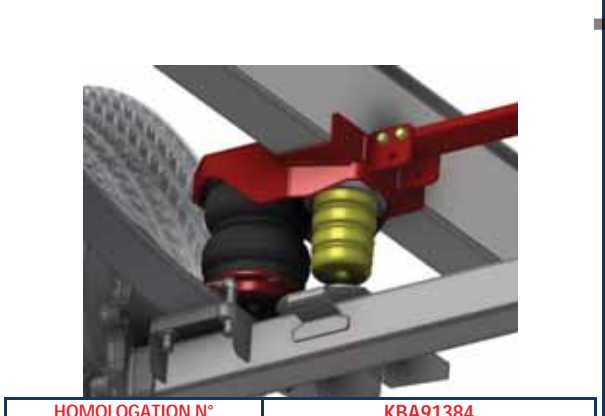

Torpress 279 B
Ø6"
550041 - 550031

HOMOLOGATION N° **KBA91384**



Corredato di
Equipped with
TOP DRIVE CONTROL



Top Drive System Ref. :  **43013291**
43013299 

M	Gonfiaggio <i>Inflating</i> Manuale <i>Manual</i>
AC	Controllo Automatico <i>Automatic control</i>

Master 3 (X62)
Versione rinforzata / Reinforced version
R330 - R350 (Euro 4 - Euro 5)

Data / Date		Dettagli veicolo / Vehicle's detail	
Da / Since :	03/2010		Passo superiore a 3682 mm <i>Wheelbase over 3682 mm</i>
Fino a / Until:	05/2014		
Tipo assale / Axle type		Ruota / Wheel	
	Quadro / Square		Singola - trazione anteriore Single - FWD

Posteriore
Rear



Torpress 281
Ø8"
550043 - 550033



HOMOLOGATION N° **KBA91384**

Corredato di
Equipped with
TOP DRIVE CONTROL





Sospensioni Integrative per veicoli commerciali Integrative Suspensions for commercial vehicles



Top Drive System Ref. :		Gonfiaggio <i>Inflating</i>	Posteriore <i>Rear</i>
43013261	M	Manuale <i>Manual</i>	
43013269	AC	Controllo Automatico <i>Automatic control</i>	Torpress 275 C
Master 3 (X62)			
Versione comfort / Comfort version			Ø7.3"
R330 - R350 (Euro 4 - Euro 5)			550054
Data / Date		Dettagli veicolo / Vehicle's detail	
Da / Since :	03/2010		Passo superiore a 3682 mm <i>Wheelbase over 3682 mm</i>
Fino a / Until:	05/2014		
Tipo assale / Axle type		Ruota / Wheel	
	Quadro / Square		Singola - trazione anteriore <i>Single - FWD</i>

Corredato di
Equipped with

Top Drive System Ref. :		Gonfiaggio <i>Inflating</i>	Posteriore <i>Rear</i>
43013251	M	Manuale <i>Manual</i>	
43013259	AC	Controllo Automatico <i>Automatic control</i>	Torpress 291 B
Master 3 (X62)			
Versione super comfort / Super comfort version			Ø10"
R330 - R350 (Euro 4 - Euro 5)			550056
Data / Date		Dettagli veicolo / Vehicle's detail	
Da / Since :	03/2010		Passo superiore a 3682 mm <i>Wheelbase over 3682 mm</i>
Fino a / Until:	05/2014		
Tipo assale / Axle type		Ruota / Wheel	
	Quadro / Square		Singola - trazione anteriore <i>Single - FWD</i>

Corredato di
Equipped with

Top Drive System Ref. :		Gonfiaggio <i>Inflating</i>	Posteriore <i>Rear</i>
43013271	M	Manuale <i>Manual</i>	
43013279	AC	Controllo Automatico <i>Automatic control</i>	Torpress 291 B
Master 3 (X62)			
Versione speciale per Ambulanza Ambulance special version			Ø10"
R330 - R350 (Euro 4 - Euro 5)			550056
Data / Date		Dettagli veicolo / Vehicle's detail	
Da / Since :	03/2010		
Fino a / Until:	05/2014		
Tipo assale / Axle type		Ruota / Wheel	
	Quadro / Square		Singola - trazione anteriore <i>Single - FWD</i>

Corredato di
Equipped with



Sospensioni Integrative per veicoli commerciali Integrative Suspensions for commercial vehicles



Top Drive System Ref. : 43013401 43013409 Master 3 (X62) R330 - R350 (Euro 4 - Euro 5)		Gonfiaggio <i>Inflating</i>	Posteriore <i>Rear</i>
	M	Manuale <i>Manual</i>	
	AC	Controllo Automatico <i>Automatic control</i>	Torpress 279 B Ø6" 550041 - 550031



Data / Date		Dettagli veicolo / Vehicle's detail	
Da / Since :	03/2010		Passo fino a 3682 mm <i>Wheelbase up to 3682 mm</i>
Fino a / Until:	05/2014		
Tipo assale / Axle type		Ruota / Wheel	
	Tondo / Round		Singola - trazione posteriore <i>Single - RWD</i>



Corredato di
Equipped with



Top Drive System Ref. : 43013491 43013499 Master 3 (X62) Versione rinforzata / Reinforced version R330 - R350 (Euro 4 - Euro 5)		Gonfiaggio <i>Inflating</i>	Posteriore <i>Rear</i>
	M	Manuale <i>Manual</i>	
	AC	Controllo Automatico <i>Automatic control</i>	Torpress 281 Ø8" 550043 - 550033



Data / Date		Dettagli veicolo / Vehicle's detail	
Da / Since :	03/2010		
Fino a / Until:	05/2014		
Tipo assale / Axle type		Ruota / Wheel	
	Tondo / Round		Singola - trazione posteriore <i>Single - RWD</i>



Corredato di
Equipped with



Top Drive System Ref. : 43013461 43013469 Master 3 (X62) Versione comfort / Comfort version R330 - R350 (Euro 4 - Euro 5)		Gonfiaggio <i>Inflating</i>	Posteriore <i>Rear</i>
	M	Manuale <i>Manual</i>	
	AC	Controllo Automatico <i>Automatic control</i>	Torpress 275 C Ø7.3" 550054



Data / Date		Dettagli veicolo / Vehicle's detail	
Da / Since :	03/2010		Passo superiore a 3682 mm <i>Wheelbase over 3682 mm</i>
Fino a / Until:	05/2014		
Tipo assale / Axle type		Ruota / Wheel	
	Tondo / Round		Singola - trazione posteriore <i>Single - RWD</i>



Corredato di
Equipped with





Sospensioni Integrative per veicoli commerciali Integrative Suspensions for commercial vehicles



Top Drive System Ref. :			Gonfiaggio <i>Inflating</i>	Posteriore <i>Rear</i>
43013301		M	Manuale <i>Manual</i>	
43013309		AC	Controllo Automatico <i>Automatic control</i>	
Master 3 (X62)				
R330 - R350 (Euro 4 - Euro 5)				
Data / Date		Dettagli veicolo / Vehicle's detail		
Da / Since :	03/2010		Passo fino a 3682 mm <i>Wheelbase up to 3682 mm</i>	
Fino a / Until:	05/2014			
Tipo assale / Axle type		Ruota / Wheel		
	Tondo / Round		Gemellata <i>Tween</i>	
		Torpress 279 B		
		Ø6"		
		550041 - 550031		

Corredato di
Equipped with

Top Drive System Ref. :			Gonfiaggio <i>Inflating</i>	Posteriore <i>Rear</i>
43013391		M	Manuale <i>Manual</i>	
43013399		AC	Controllo Automatico <i>Automatic control</i>	
Master 3 (X62)				
Versione rinforzata / Reinforced version				
R330 - R350 (Euro 4 - Euro 5)				
Data / Date		Dettagli veicolo / Vehicle's detail		
Da / Since :	03/2010		Passo superiore a 3682 mm <i>Wheelbase over 3682 mm</i>	
Fino a / Until:	05/2014			
Tipo assale / Axle type		Ruota / Wheel		
	Tondo / Round		Gemellata <i>Tween</i>	
		Torpress 281		
		Ø8"		
		550043 - 550033		

Corredato di
Equipped with

Top Drive System Ref. :			Gonfiaggio <i>Inflating</i>	Posteriore <i>Rear</i>
43013361		M	Manuale <i>Manual</i>	
43013369		AC	Controllo Automatico <i>Automatic control</i>	
Master 3 (X62)				
Versione comfort / Comfort version				
R330 - R350 (Euro 4 - Euro 5)				
Data / Date		Dettagli veicolo / Vehicle's detail		
Da / Since :	03/2010		Passo superiore a 3682 mm <i>Wheelbase over 3682 mm</i>	
Fino a / Until:	05/2014			
Tipo assale / Axle type		Ruota / Wheel		
	Tondo / Round		Gemellata <i>Tween</i>	
		Torpress 275 C		
		Ø7.3"		
		550054		

Corredato di
Equipped with



Sospensioni Integrative per veicoli commerciali Integrative Suspensions for commercial vehicles



Top Drive System Ref. :

583711

Master 3 (X62) - 2014

Molle rinforzate per assale anteriore (conf. Da 2 pezzi) /
front axle reinforced springs (2 pcs. package)

Anteriore
Front



Nuovo / New



Data / Date		Dettagli veicolo / Vehicle's detail	
Da / Since :	05/2014		
Fino a / Until:			
Tipo assale / Axle type		Ruota / Wheel	
NA	Non applicabile / Not Applicable		Mc Pherson Mc Pherson

Top Drive System Ref. :

583132

583132AC

Master 3 (X62) - 2014

R330 - R350 (Euro 4 - Euro 5)



Gonfiaggio
Inflating

M

Manuale
Manual

AC

Controllo Automatico
Automatic control

Posteriore
Rear

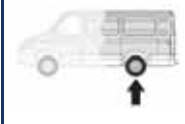

Nuovo / New



Data / Date		Dettagli veicolo / Vehicle's detail	
Da / Since :	05/2014		Passo fino a 3682 mm <i>Wheelbase up to 3682 mm</i>
Fino a / Until:			
Tipo assale / Axle type		Ruota / Wheel	
	Quadro / Square		Singola - trazione anteriore Single - FWD



Corredato di
Equipped with
TOP DRIVE CONTROL

Top Drive System Ref. :

43013201

43013209

Master 3 (X62) - 2014

R330 - R350 (Euro 4 - Euro 5)



Gonfiaggio
Inflating

M

Manuale
Manual

AC

Controllo Automatico
Automatic control

Posteriore
Rear

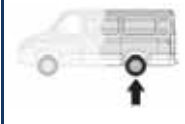

Nuovo / New



Data / Date		Dettagli veicolo / Vehicle's detail	
Da / Since :	05/2014		Passo fino a 3682 mm <i>Wheelbase up to 3682 mm</i>
Fino a / Until:			
Tipo assale / Axle type		Ruota / Wheel	
	Quadro / Square		Singola - trazione anteriore Single - FWD



HOMOLOGATION N°
KBA91384

Corredato di
Equipped with
TOP DRIVE CONTROL



Sospensioni Integrative per veicoli commerciali Integrative Suspensions for commercial vehicles



Top Drive System Ref. : 43013291 43013299		Gonfiaggio <i>Inflating</i>	Posteriore <i>Rear</i>		Nuovo / New
		Manuale <i>Manual</i>	Torpress 281 Ø8"		
Master 3 (X62) - 2014 Versione rinforzata / Reinforced version R330 - R350 (Euro 4 - Euro 5)		Controllo Automatico <i>Automatic control</i>			
Data / Date		Dettagli veicolo / Vehicle's detail			
Da / Since : 05/2014		Passo superiore a 3682 mm Wheelbase over 3682 mm			
Fino a / Until:	Ruota / Wheel				
Tipo assale / Axle type	Quadro / Square		Singola - trazione anteriore Single - FWD		
	HOMOLOGATION N° KBA91384				
	Corredato di Equipped with TOP DRIVE CONTROL				

Top Drive System Ref. : 43013261 43013269		Gonfiaggio <i>Inflating</i>	Posteriore <i>Rear</i>		Nuovo / New
		Manuale <i>Manual</i>	Torpress 275 C Ø7.3"		
Master 3 (X62) - 2014 Versione comfort / Comfort version R330 - R350 (Euro 4 - Euro 5)		Controllo Automatico <i>Automatic control</i>			
Data / Date		Dettagli veicolo / Vehicle's detail			
Da / Since : 05/2014		Passo superiore a 3682 mm Wheelbase over 3682 mm			
Fino a / Until:	Ruota / Wheel				
Tipo assale / Axle type	Quadro / Square		Singola - trazione anteriore Single - FWD		
	Corredato di Equipped with TOP DRIVE CONTROL				
	Corredato di Equipped with TOP DRIVE CONTROL				

Top Drive System Ref. : 43013251 43013259		Gonfiaggio <i>Inflating</i>	Posteriore <i>Rear</i>		Nuovo / New
		Manuale <i>Manual</i>	Torpress 291 B Ø10"		
Master 3 (X62) - 2014 Versione super comfort / Super comfort version R330 - R350 (Euro 4 - Euro 5)		Controllo Automatico <i>Automatic control</i>			
Data / Date		Dettagli veicolo / Vehicle's detail			
Da / Since : 05/2014		Passo superiore a 3682 mm Wheelbase over 3682 mm			
Fino a / Until:	Ruota / Wheel				
Tipo assale / Axle type	Quadro / Square		Singola - trazione anteriore Single - FWD		
	Corredato di Equipped with TOP DRIVE CONTROL				
	Corredato di Equipped with TOP DRIVE CONTROL				



Sospensioni Integrative per veicoli commerciali Integrative Suspensions for commercial vehicles



Top Drive System Ref. :			Gonfiaggio <i>Inflating</i>	Posteriore <i>Rear</i>
43013271		M	Manuale <i>Manual</i>	
43013279		AC	Controllo Automatico <i>Automatic control</i>	
Master 3 (X62) - 2014				
Versione speciale per Ambulanza Ambulance special version				
R330 - R350 (Euro 4 - Euro 5)				
Completa di balestre / <i>With leaf springs included</i>				
Data / Date		Dettagli veicolo / Vehicle's detail		
Da / Since :	05/2014			
Fino a / Until:				
Tipo assale / Axle type		Ruota / Wheel		
	Quadro / Square		Singola - trazione anteriore <i>Single - FWD</i>	

Nuovo / New





Corredato di
Equipped with



Top Drive System Ref. :			Gonfiaggio <i>Inflating</i>	Posteriore <i>Rear</i>
43013401		M	Manuale <i>Manual</i>	
43013409		AC	Controllo Automatico <i>Automatic control</i>	
Master 3 (X62) - 2014				
R330 - R350 (Euro 4 - Euro 5)				
Data / Date		Dettagli veicolo / Vehicle's detail		
Da / Since :	05/2014		Passo fino a 3682 mm <i>Wheelbase up to 3682 mm</i>	
Fino a / Until:				
Tipo assale / Axle type		Ruota / Wheel		
	Tondo / Round		Singola - trazione posteriore <i>Single - RWD</i>	

Nuovo / New





Corredato di
Equipped with



Top Drive System Ref. :			Gonfiaggio <i>Inflating</i>	Posteriore <i>Rear</i>
43013491		M	Manuale <i>Manual</i>	
43013499		AC	Controllo Automatico <i>Automatic control</i>	
Master 3 (X62) - 2014				
Versione rinforzata / Reinforced version				
R330 - R350 (Euro 4 - Euro 5)				
Data / Date		Dettagli veicolo / Vehicle's detail		
Da / Since :	05/2014		Passo superiore a 3682 mm <i>Wheelbase over 3682 mm</i>	
Fino a / Until:				
Tipo assale / Axle type		Ruota / Wheel		
	Tondo / Round		Singola - trazione posteriore <i>Single - RWD</i>	

Nuovo / New





Corredato di
Equipped with





Sospensioni Integrative per veicoli commerciali Integrative Suspensions for commercial vehicles



Top Drive System Ref. : 43013461 43013469		 M Manuale <i>Manual</i>	Posteriore Rear Torpress 275 C Ø7.3" 550054	Nuovo / New
Master 3 (X62) - 2014 Versione comfort / Comfort version R330 - R350 (Euro 4 - Euro 5)		 AC Controllo Automatico <i>Automatic control</i>	 Torpress 275 C Ø7.3" 550054	 Corredato di Equipped with TOP DRIVE CONTROL
Data / Date Da / Since : 05/2014 Fino a / Until:		Dettagli veicolo / Vehicle's detail Passo superiore a 3682 mm Wheelbase over 3682 mm		
Tipo assale / Axle type Tondo / Round		Ruota / Wheel Singola - trazione posteriore Single - RWD		

Top Drive System Ref. : 43013301 43013309		 M Manuale <i>Manual</i>	Posteriore Rear Torpress 279 B Ø6" 550041 - 550031	Nuovo / New
Master 3 (X62) - 2014 R330 - R350 (Euro 4 - Euro 5)		 AC Controllo Automatico <i>Automatic control</i>	 Torpress 279 B Ø6" 550041 - 550031	 Corredato di Equipped with TOP DRIVE CONTROL
Data / Date Da / Since : 05/2014 Fino a / Until:		Dettagli veicolo / Vehicle's detail Passo fino a 3682 mm Wheelbase up to 3682 mm		
Tipo assale / Axle type Tondo / Round		Ruota / Wheel Gemellata Tween		

Top Drive System Ref. : 43013391 43013399		 M Manuale <i>Manual</i>	Posteriore Rear Torpress 281 Ø8" 550043 - 550033	Nuovo / New
Master 3 (X62) - 2014 Versione rinforzata / Reinforced version R330 - R350 (Euro 4 - Euro 5)		 AC Controllo Automatico <i>Automatic control</i>	 Torpress 281 Ø8" 550043 - 550033	 Corredato di Equipped with TOP DRIVE CONTROL
Data / Date Da / Since : 05/2014 Fino a / Until:		Dettagli veicolo / Vehicle's detail Passo superiore a 3682 mm Wheelbase over 3682 mm		
Tipo assale / Axle type Tondo / Round		Ruota / Wheel Gemellata Tween		



Sospensioni Integrative per veicoli commerciali Integrative Suspensions for commercial vehicles



Top Drive System Ref. : 43013361 43013369		Gonfiaggio <i>Inflating</i>	Posteriore <i>Rear</i>		Nuovo / New
		Manuale <i>Manual</i>	Torpress 275 C Ø7.3"		
Master 3 (X62) - 2014 Versione comfort / Comfort version R330 - R350 (Euro 4 - Euro 5)		Controllo Automatico <i>Automatic control</i>			Corredato di Equipped with TOP DRIVE CONTROL
Data / Date Da / Since : 05/2014 Fino a / Until:	Dettagli veicolo / Vehicle's detail Passo superiore a 3682 mm Wheelbase over 3682 mm	Tipo assale / Axle type Tondo / Round	Ruota / Wheel Gemellata Tween		

Top Drive System Ref. : 42653101 42653109		Gonfiaggio <i>Inflating</i>	Anteriore <i>Front</i>		
		Manuale <i>Manual</i>	Torpress T 279 E Ø6"		
Maxity F24 Dxi 2,5 35q ÷ 45q Dxi 3 35q ÷ 45q		Controllo Automatico <i>Automatic control</i>			Corredato di Equipped with TOP DRIVE CONTROL
Data / Date Da / Since : 10/2006 Fino a / Until:	Dettagli veicolo / Vehicle's detail	Tipo assale / Axle type Non applicabile / Not Applicable	Ruota / Wheel Quadrilateri trasversali Double wishbone		

Top Drive System Ref. : 583532 583532AC		Gonfiaggio <i>Inflating</i>	Posteriore <i>Rear</i>		
		Manuale <i>Manual</i>	Torpress 279 B Ø6"		
Maxity F 24 Dxi 2,5 35q ÷ 45q Dxi 3 35q ÷ 45q		Controllo Automatico <i>Automatic control</i>			Corredato di Equipped with TOP DRIVE CONTROL
Data / Date Da / Since : 06/2006 Fino a / Until:	Dettagli veicolo / Vehicle's detail	Tipo assale / Axle type Tondo / Round Ø80	Ruota / Wheel Gemellata Tween		



Sospensioni Integrative per veicoli commerciali Integrative Suspensions for commercial vehicles



Top Drive System Ref. :			Gonfiaggio <i>Inflating</i>	Posteriore <i>Rear</i>
42600401		M	Manuale <i>Manual</i>	
42600409		AC	Controllo Automatico <i>Automatic control</i>	
D2.0				
3,5 ÷ 5 t / 3,5 ÷ 5 tons				
Data / Date		Dettagli veicolo / Vehicle's detail		
Da / Since :	04/2014			
Fino a / Until:				
Tipo assale / Axle type		Ruota / Wheel		
	Tondo / Round Ø94		Gemellata Tween	
		Torpress 275 C		
		Ø7.3"		
		550054		

Nuovo / New

Corredato di
Equipped with

Top Drive System Ref. :			Gonfiaggio <i>Inflating</i>	Posteriore <i>Rear</i>
42600601		M	Manuale <i>Manual</i>	
42600609		AC	Controllo Automatico <i>Automatic control</i>	
D2.0				
3,5 ÷ 5 t / 3,5 ÷ 5 tons				
Data / Date		Dettagli veicolo / Vehicle's detail		
Da / Since :	04/2014			
Fino a / Until:				
Tipo assale / Axle type		Ruota / Wheel		
	Quadro / Square BxH=93x120		Gemellata Tween	
		Torpress 275 C		
		Ø7.3"		
		550054		

Nuovo / New

Corredato di
Equipped with

Top Drive System Ref. :			Gonfiaggio <i>Inflating</i>	Posteriore <i>Rear</i>
42600491		M	Manuale <i>Manual</i>	
42600499		AC	Controllo Automatico <i>Automatic control</i>	
D2.0				
Versione rinforzata / Reinforced version				
5 t / 5 tons				
Data / Date		Dettagli veicolo / Vehicle's detail		
Da / Since :	04/2014			
Fino a / Until:				
Tipo assale / Axle type		Ruota / Wheel		
	Quadro / Square 92x120		Gemellata Tween	
		Torpress G288/3B		
		Ø5.5"		
		550023		

Nuovo / New

Corredato di
Equipped with



Sospensioni Integrative per veicoli commerciali Integrative Suspensions for commercial vehicles



Top Drive System Ref. : 42600301 42600303 42600304 D2.0 6,5 ÷ 7,5 t / 6,5 ÷ 7,5 tons		Gonfiaggio <i>Inflating</i>	Anteriore <i>Front</i>	
	M	Manuale <i>Manual</i>		
	A	Autolivellante <i>Self-levelling</i>	Torpress 281	
	E	Elettrico <i>Electric</i>	 Ø8" 550043 - 550033	
Data / Date		Dettagli veicolo / Vehicle's detail		
Da / Since :	04/2014			
Fino a / Until:				
Tipo assale / Axle type		Ruota / Wheel		
I	- / -	NA	NA NA	Corredato di <i>Equipped with</i>

Top Drive System Ref. : 42600391 42600393 42600394 D2.0 Versione rinforzata / Reinforced version 6,5 ÷ 7,5 t / 6,5 ÷ 7,5 tons		Gonfiaggio <i>Inflating</i>	Anteriore <i>Front</i>	
	M	Manuale <i>Manual</i>		
	A	Autolivellante <i>Self-levelling</i>	Torpress 291 B	
	E	Elettrico <i>Electric</i>	 Ø10" 550056	
Data / Date		Dettagli veicolo / Vehicle's detail		
Da / Since :	04/2014			
Fino a / Until:				
Tipo assale / Axle type		Ruota / Wheel		
I	- / -	NA	NA NA	Corredato di <i>Equipped with</i>

Top Drive System Ref. : 42600291 42600293 42600294 D2.0 6,5 ÷ 7,5 t / 6,5 ÷ 7,5 tons		Gonfiaggio <i>Inflating</i>	Posteriore <i>Rear</i>	
	M	Manuale <i>Manual</i>		
	A	Autolivellante <i>Self-levelling</i>	Torpress 279 B	
	E	Elettrico <i>Electric</i>	 Ø6" 550041 - 550031	
Data / Date		Dettagli veicolo / Vehicle's detail		
Da / Since :	04/2014			
Fino a / Until:				
Tipo assale / Axle type		Ruota / Wheel		
	Quadro / Square 92x120		Gemellata Tween	Corredato di <i>Equipped with</i>